



CATALOG SCULE PENTRU CENTRE DE STANTAT SALVAGNINI

Distributor:
S.C. SM TECH S.R.L.
www.sm-tech.ro
www.wilsontool.ro
office @ sm-tech.ro
Tel: 0374-991480
Tel mob: 0745-528494
Fax: 0374-091010



SALVAGNINI TOOLING



Strength. Performance. Innovation.

SHEAR OPTIONS AND COATINGS

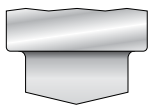
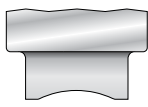
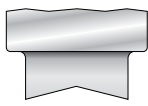
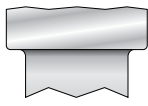
SHEAR OPTIONS

TYPE OF SHEAR	BENEFIT	LIMITATION
 Rooftop	Best shear for punching at maximum tonnages.	When nibbling, bite must be 75% of punch dimension or excessive side loading will result.
 Concave or Double Concave	Best shear for nibbling because it inverts stresses.	The punch is less resistant to breakage when punching at high tonnages because of inverted stresses.
 Inverted Rooftop	Also good shear for nibbling because it inverts stresses.	More susceptible to breakage because of a sharp focal point for stresses - use great care.
 Double Valley Shear	Best shear for nibbling when shape is long and narrow.	The punch is less resistant to breakage when punching at high tonnages because of inverted stresses.
 JK Shear	A special punch tip shear that allows you to punch high strength materials with a reduced risk of breakage.	Can only be used on punches up to 25.4mm diameter or 'A' dimension†.

COATING OPTIONS



OPTIMA® coating provides significantly longer tool life, more hits between sharpenings, reduced galling, better performance and less downtime. With a surface hardness of 95 Rockwell C, Optima far exceeds the hardness levels that can be achieved with conventional tool steels. It resists galling in stainless and galvanized steel and is unaffected by sharpening.



WEAR-BEATER™ coating is a titanium nitride (TiN) coating that helps reduce galling and extends punch life in certain applications.



SLIP-MAX™ coating's combination of hardness and lubricity greatly increases punch life and reduces galling when piercing aluminum. Slip-Max is also very effective in resolving even the most challenging stripping problems with punching or forming stainless steel and aluminum.

TOOLING OVERVIEW

HEAD POSITION	TOOL TYPE	STATION	SIZE RANGE	NOTES
1 - 20 and 41 - 76 [7 Tons]	WPA	33 mm	0.79 - 6 mm	Round Only
	WP0	33 mm	0.79 - 10 mm	Fully Guided
	WPB	33 mm	6 - 10.5 mm	Round Only
	WP9	33 mm	Up to 26 mm	Fully Guided
	WS4	33 mm	Up to 33 mm	
30 - 35 [12 Tons]	WP5	60 mm	Up to 42.4 mm	Rotational
	WS6	60 mm	Up to 60 mm	Rotational
21 - 24 [26 Tons]	WS8	70 x 90 mm	70 x 90 mm	Type 70
	WS9	70 x 90 mm	70 x 90 mm	Type 90
	WSA	90 x 90 mm	90 x 90 mm	Type 90

Wilson Tool types are compatible with Salvagnini S4, S6, S8, S9, SA, P0, P9, P5 and Mate tool types PA and PB

TOOLING ORIENTATION

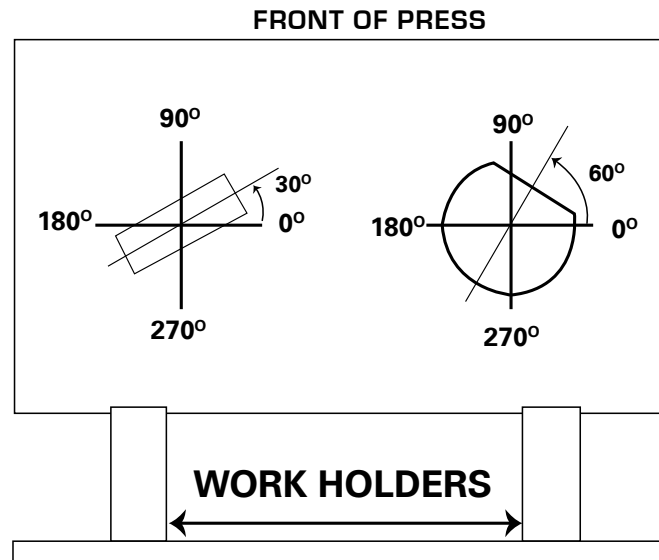

Note: Please refer to non-standard key locations by the following method:

- Example 1 "Shape at 30°"
- Example 2 "Shape at 60°"

	STANDARD SHAPE						DIE VIEW				
0°											
90°											
180°											
270°											



WPA



WPB



WS4

DESCRIPTION	WPA 0.79 - 6 mm	PRICE	WPB 6 - 10.5 mm	PRICE
Punch Holder w/Locking Screw	17610		17612	
Punch Locking Screw	25212		25212	
Punch - Round	17611		17613	
Optima Add-On				
Stripper - Round	17502		17502	
Die - Round	17716		17716	
Die - Round Slug Hugger® 2	17718		17718	
Die Shim Pack*	17602		17602	

DESCRIPTION	WS4 Up to 33 mm	PRICE
Punch - Round	17500	
Punch - Shape	17501	
Optima Add-On		
Stripper - Round	17502	
Stripper - Shape	17503	
Die - Round [0 - 10.5 mm]	17716	
Die - Round [10.5 - 33 mm]	17504	
Die - Round Slug Hugger® 2 [0 - 10.5 mm]	17718	
Die - Round Slug Hugger® 2 [10.5 - 33 mm]	17604	
Die - Shape [0 - 10.5 mm]	17717	
Die - Shape [10.5 - 33 mm]	17505	
Die - Shape Slug Hugger® 2 [0 - 10.5 mm]	17719	
Die - Shape Slug Hugger® 2 [10.5 - 33 mm]	17605	
Die Shim Pack*	17602	

Grind Life for WPA, WPB, WS4:

Punches can be resharpened 4 mm

Dies can be resharpened 1.5 mm

* Die Shim Pack includes:

- 5 each 0.1 mm
- 3 each 0.2 mm
- 2 each 0.3 mm

H3 HEAD

	30	31	32	33	34	35
24 90 x 90	76	68	60	56	52	48
	75	67	59	55	51	47
23 70 x 90	74	66	58	54	50	46
	73	65	57	53	49	45
22 70 x 90	72	64	20	16	12	8
	71	63	19	15	11	7
21 90 x 90	70	62	18	14	10	6
	69	61	17	13	9	5

HEAD POSITIONS
1-20, 41-76 7 TON

STANDARD SHAPE							DIE VIEW			

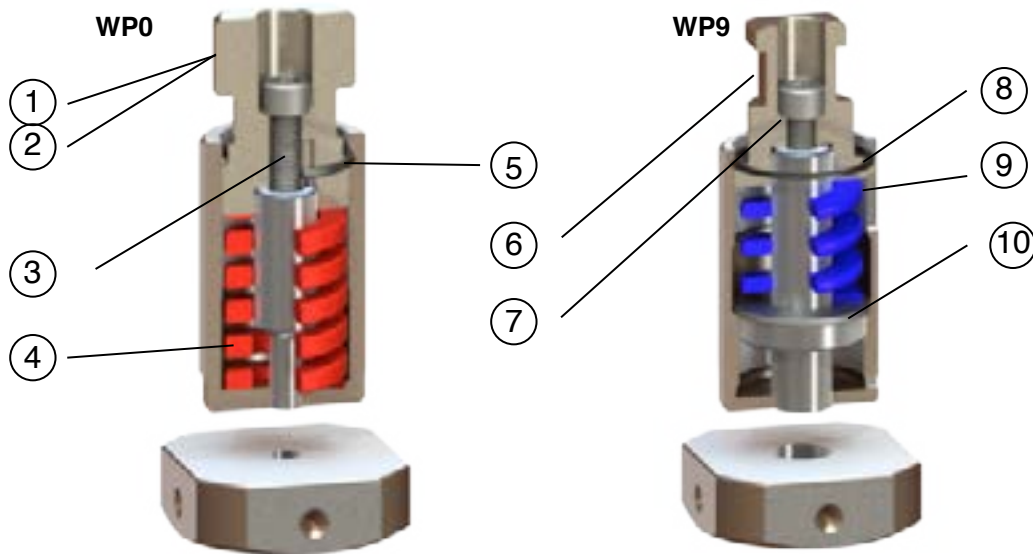

DESCRIPTION	WP0 0.79 - 10 mm	PRICE
Punch Assembly - Round	17510	
Punch Assembly - Shape	17511	
Punch - Round	17512	
Punch - Shape	17513	
Optima Add-On		
Stripping Guide - Round	17514	
Stripping Guide - Shape	17515	
Die - Round	17716	
Die - Round Slug Hugger® 2	17718	
Die - Shape	17717	
Die - Shape Slug Hugger® 2	17719	
Die Shim Pack*	17602	
1 Punch Holder - Round	17516	
2 Punch Holder - Shaped	17517	
3 Socket Head Cap Screw	6409	
4 Spring	980644	
5 Retaining Ring	980572	

DESCRIPTION	WP9 Up to 26 mm	PRICE
Punch Assembly - Round	17529	
Punch Assembly - Shape	17521	
Punch - Round	17522	
Punch - Shape	17523	
Optima® Add-On		
Stripping Guide - Round	17524	
Stripping Guide - Shape	17525	
Die - Round [0 - 10.5 mm]	17716	
Die - Round [10.5 - 33 mm]	17504	
Die - Round Slug Hugger® 2 [0 - 10.5 mm]	17718	
Die - Round Slug Hugger® 2 [10.5 - 33 mm]	17604	
Die - Shape [0 - 10.5 mm]	17717	
Die - Shape [10.5 - 33 mm]	17505	
Die - Shape Slug Hugger® 2 [0 - 10.5 mm]	17719	
Die - Shape Slug Hugger® 2 [10.5 - 33 mm]	17605	
Die Shim Pack*	17602	
6 Punch Holder	17526	
7 Socket Head Cap Screw	6416	
8 Retaining Ring	17528	
9 Spring	6241	
10 Spring Support Washer	17527	

* Die Shim Pack includes:
 5 each 0.1 mm
 3 each 0.2 mm
 2 each 0.3 mm

Grind Life for WP0

Punches can be resharpened 1.5 mm
 Dies can be resharpened 1.5 mm

Grind Life for WP9

3 mm
 1.5 mm

	STANDARD SHAPE						DIE VIEW				
0°											
90°											
180°											
270°											

H3 HEAD

	30	31	32	33	34	35
24 90 x 90	76	68	60	56	52	48
	75	67	59	55	51	47
23 70 x 90	74	66	58	54	50	46
	73	65	57	53	49	45
22 70 x 90	72	64	20	16	12	8
	71	63	19	15	11	7
21 90 x 90	70	62	18	14	10	6
	69	61	17	13	9	5

HEAD POSITIONS
 1-20, 41-76 7 TON

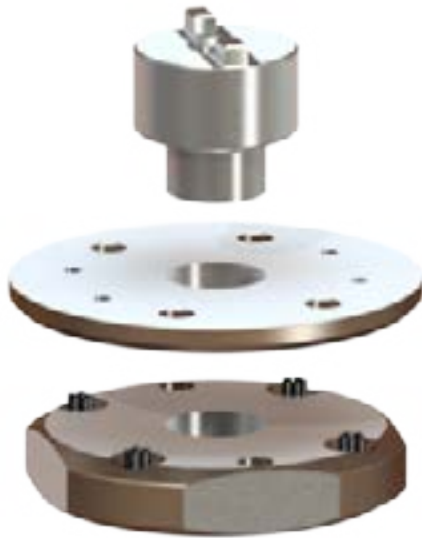

WP5



WS6

DESCRIPTION	WP5 Up to 42.4 mm	PRICE	WS6 Up to 60 mm	PRICE
Punch - Round	17532		17542	
Punch - Shape	17533		17543	
Optima® Add-On				
Stripper - Round	17534		17544	
Stripper - Shape	17535		17545	
Die - Round	17536		17536	
Die - Round Slug Hugger® 2	17636		17636	
Die - Shape	17537		17537	
Die - Shape Slug Hugger® 2	17637		17637	
Die Brush 8mm	17601		17601	

* Dies come with brushes installed.

Grind Life for WP5, WS6:

Punches can be resharpened 4 mm
Dies can be resharpened 1.5 mm

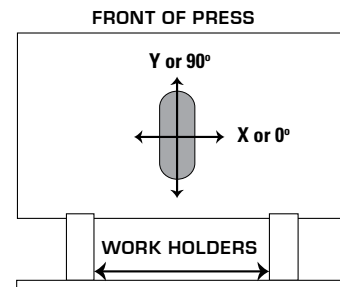

H3 HEAD

	30	31	32	33	34	35
24 90 x 90	76	68	60	56	52	48
23 70 x 90	75	67	59	55	51	47
22 70 x 90	74	66	58	54	50	46
21 90 x 90	73	65	57	53	49	45
	72	64	20	16	12	8
	71	63	19	15	11	7
	70	62	18	14	10	6
	69	61	17	13	9	5

	STANDARD SHAPE						DIE VIEW				
0°											
90°											
180°											
270°											

HEAD POSITIONS
30 - 35 12 TON

TYPE 70	WS8 70 x 90 mm	PRICE
	Type 70	
Punch - Round	17562	
Punch - Shapes	17563	
Optima® Add-On		
Stripper - Round	17564	
Stripper - Shapes	17565	
Die - Round	17566	
Die - Round Slug Hugger® 2	17666	
Die - Shape	17567	
Die - Shape Slug Hugger® 2	17667	
Large Brush 13 mm	17600	

* Die and Strippers come with brushes installed.

Type 70

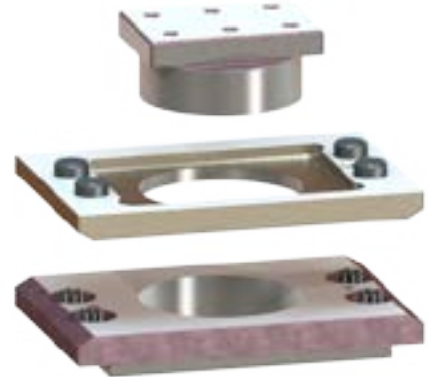

WS8

HEAD POSITIONS 21-24 26 TON

Verify what stations are in the cartridge.

TYPE 70

	30	31	32	33	34	35
24 70 x 90	76	68	60	56	52	48
	75	67	59	55	51	47
23 70 x 90	74	66	58	54	50	46
	73	65	57	53	49	45
22 70 x 90	72	64	20	16	12	8
	71	63	19	15	11	7
21 70 x 90	70	62	18	14	10	6
	69	61	17	13	9	5

Grind Life for WS8

Punches can be resharpened 4 mm
Dies can be resharpened 1.5 mm

Slug retention options available upon request.

	STANDARD SHAPE						DIE VIEW				
0°											
90°											
180°											
270°											

Type 90
70 x 90

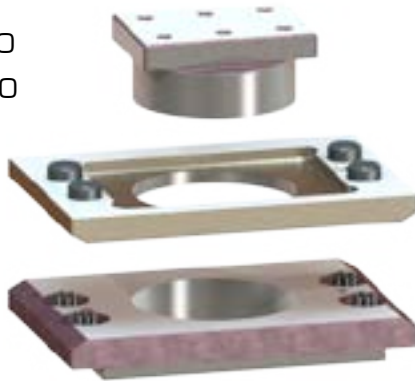

WS9

Type 90
90 x 90

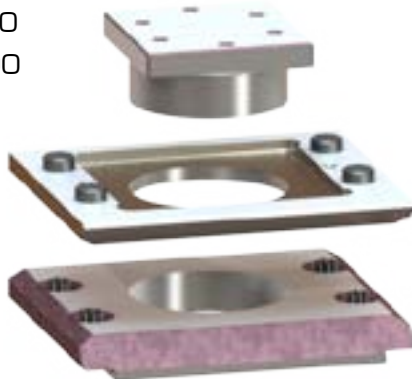

WSA

DESCRIPTION	WS9 70 x 90 mm	PRICE	WSA 90 x 90 mm	PRICE
	Type 90		Type 90	
Punch - Round	17562		17582	
Punch - Shapes	17563		17583	
Optima® Add-On				
Stripper - Round	17574		17584	
Stripper - Shapes	17575		17585	
Die - Round	17576		17586	
Die - Round Slug Hugger® 2	17676		17686	
Die - Shape	17577		17587	
Die - Shape Slug Hugger® 2	17677		17687	
Large Brush 13 mm	17600		17600	

* Die and Strippers come with brushes installed.

TYPE 90

	30	31	32	33	34	35
24 90 x 90	76	68	60	56	52	48
23 70 x 90	75	67	59	55	51	47
22 70 x 90	74	66	58	54	50	46
21 90 x 90	73	65	57	53	49	45
	72	64	20	16	12	8
	71	63	19	15	11	7
	70	62	18	14	10	6
	69	61	17	13	9	5

HEAD POSITIONS 21-24 26 TON

Verify what stations are in the cartridge.

Grind Life for WS9 & WSA

Punches can be resharpened 4 mm
Dies can be resharpened 1.5 mm

Slug retention options available upon request.

	STANDARD SHAPE						DIE VIEW				
0°											
90°											
180°											
270°											

GROUP "A"

Note: Special Considerations May Alter Price and Lead Time

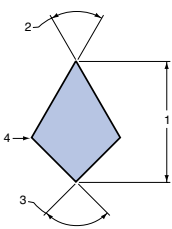

S1

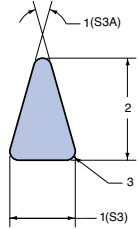

S3 -S3A

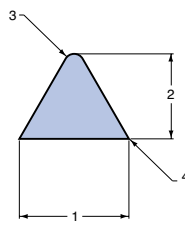

S4

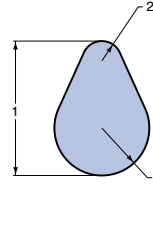

S7

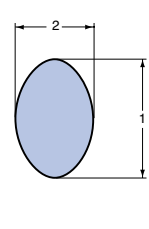

S8

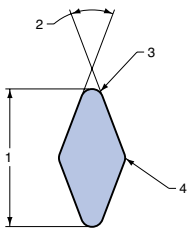

S9

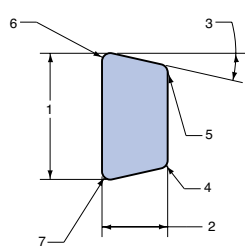

S23

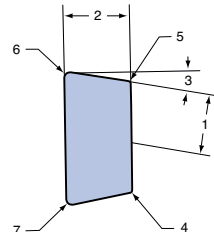

S23A

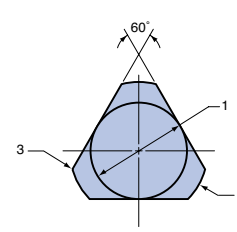

S50

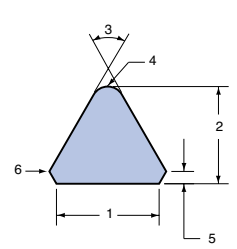

S51

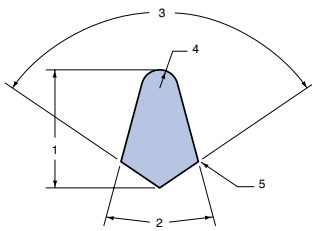

S59

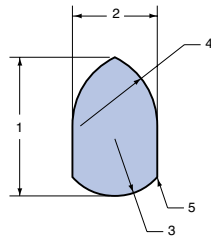

S65

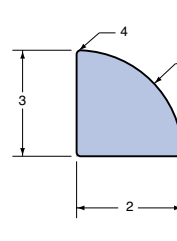

S69

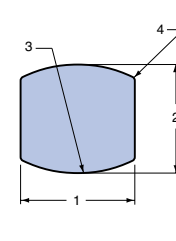

S81

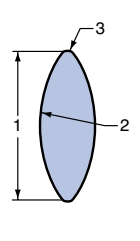

S95L

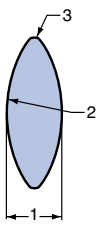

S95W

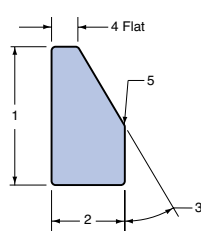

S97

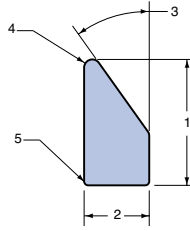

S100

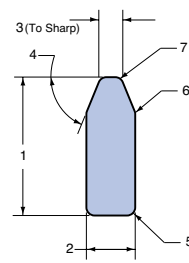

S102

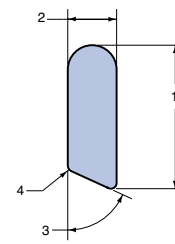

S103

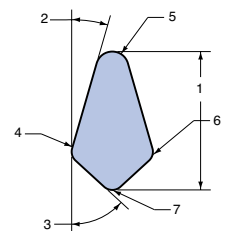

S105

GROUP "A"

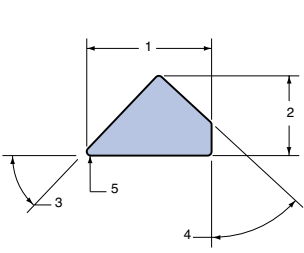

S106

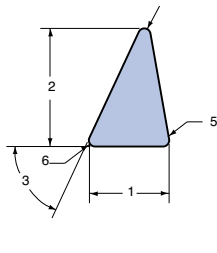

S108

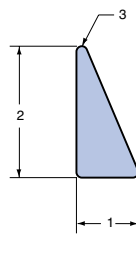

S109

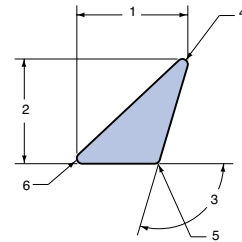

S110

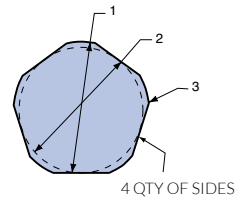

S121

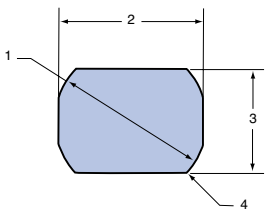

S122

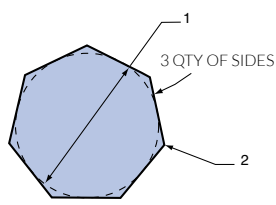

S123

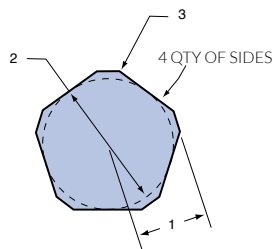

S124

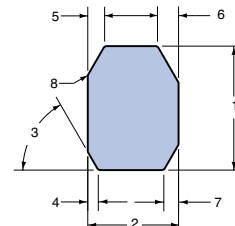

S161

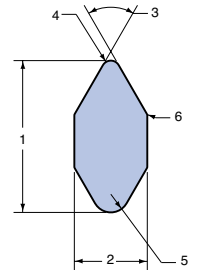

S162

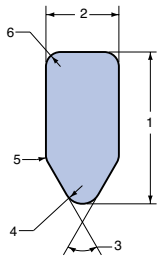

S163

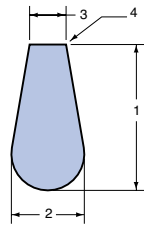

S164

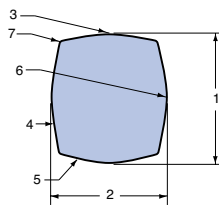

S165

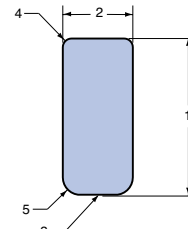

S166

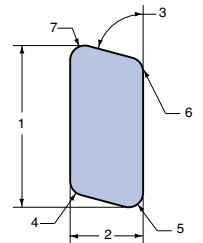

S167

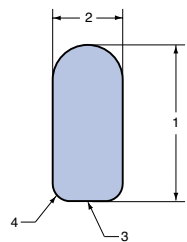

S170

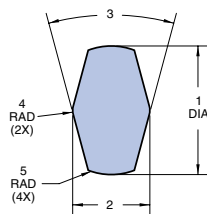

SQF

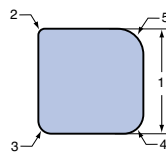

PN

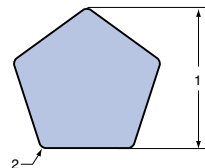

RTF

GROUP "B"

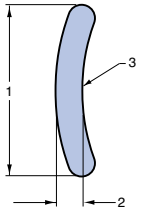

S6

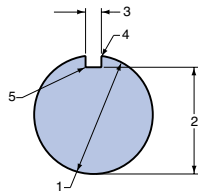

S10

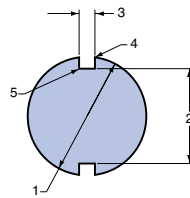

S11

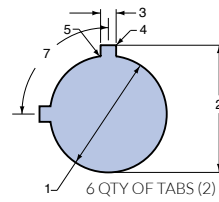

S12

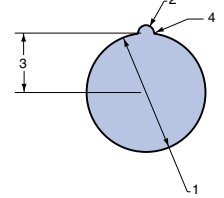

S13

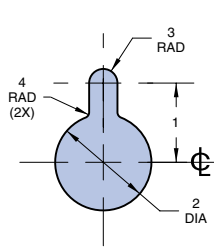

S14

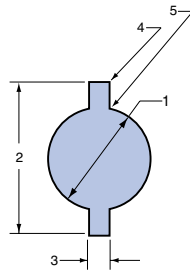

S15

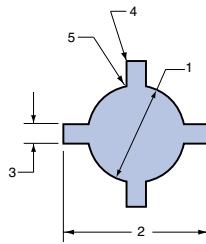

S16

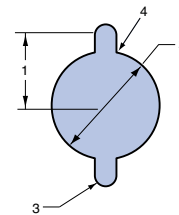

S17

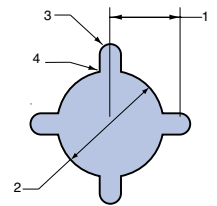

S18

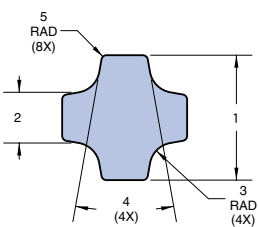

S19

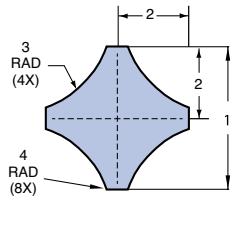

S19A

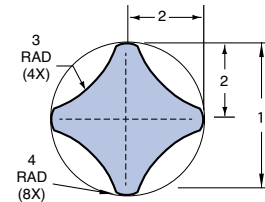

S19B

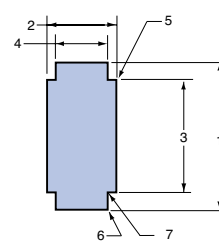

S20

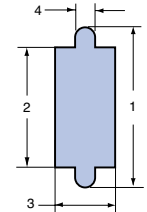

S21

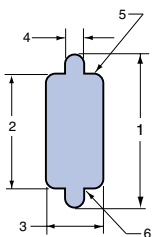

S22

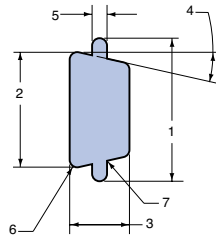

S24

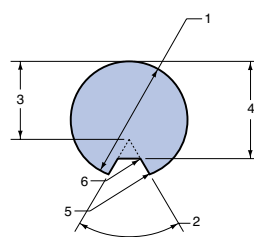

S30

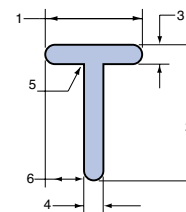

S31

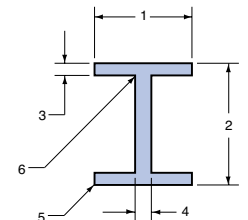

S33

GROUP "B"

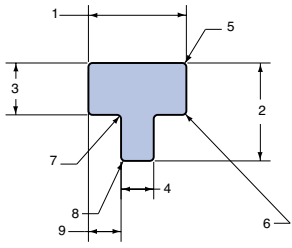

S35

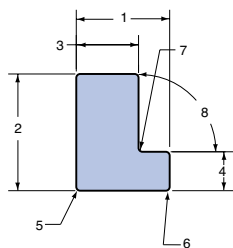

S36

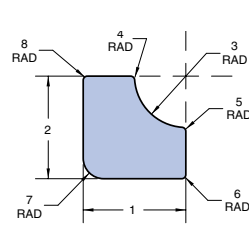

S36A

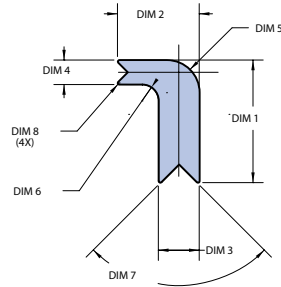

S37

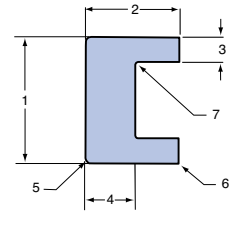

S40

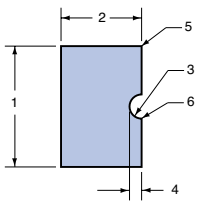

S41

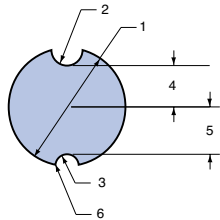

S42

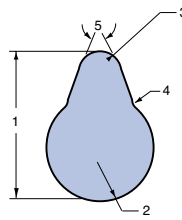

S43

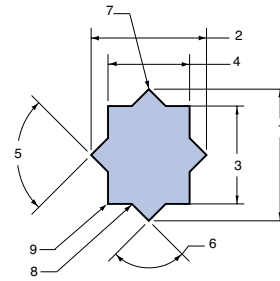

S46

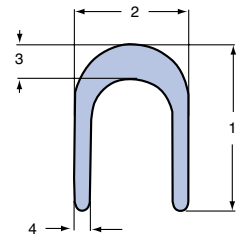

S54

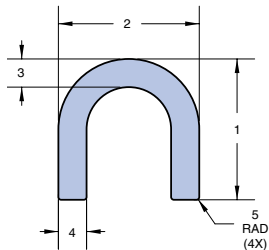

S55

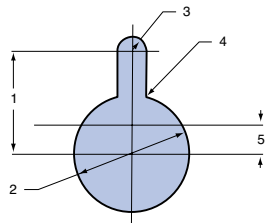

S56

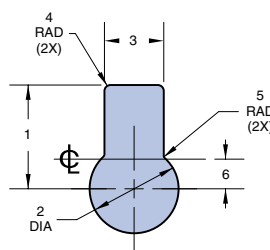

S57

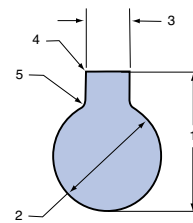

S58

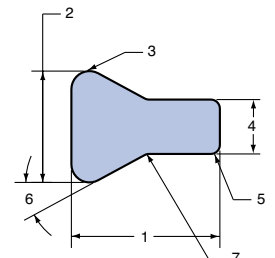

S60

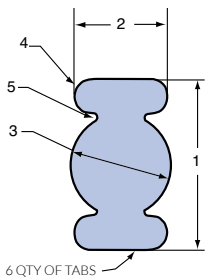

S61

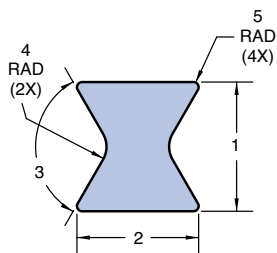

S62

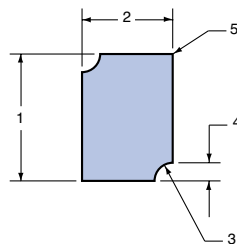

S66

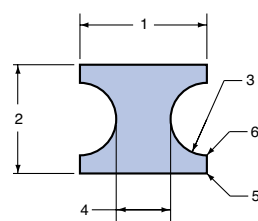

S79

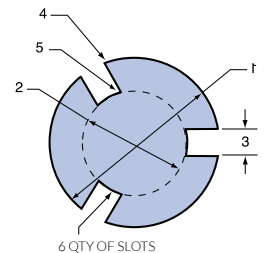

S82

GROUP "B"

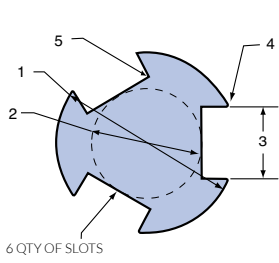

S83

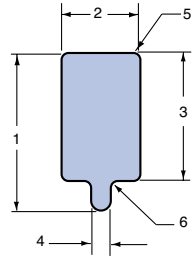

S84

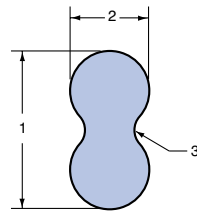

S87

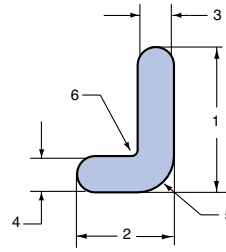

S88

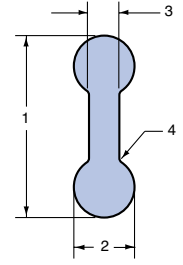

S91

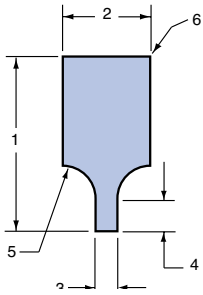

S93

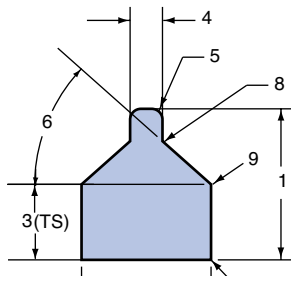

S114

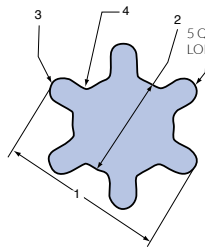

S115

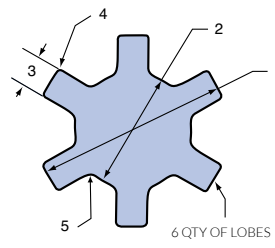

S116

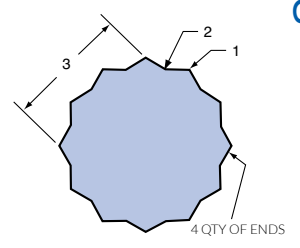

S117

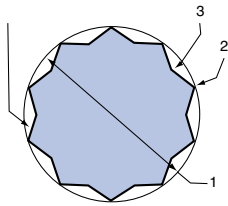

S118

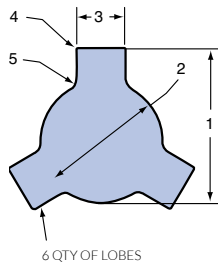

S119

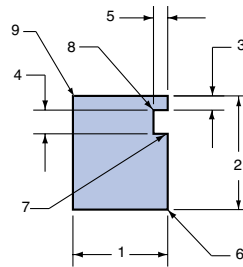

S120

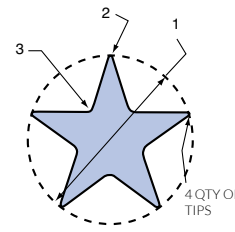

S125

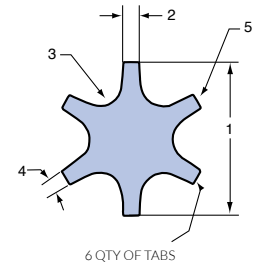

S126

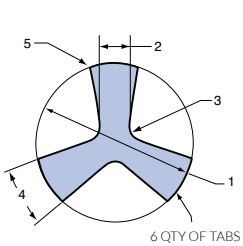

S127

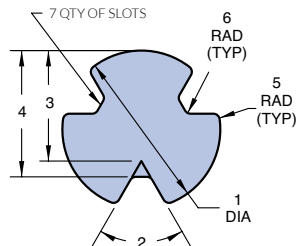

S128

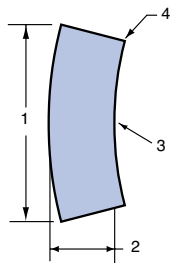

S141

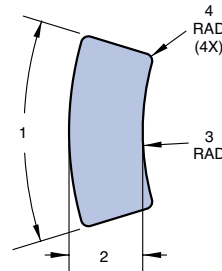

S141A

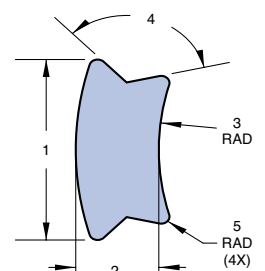

S142

GROUP "B"

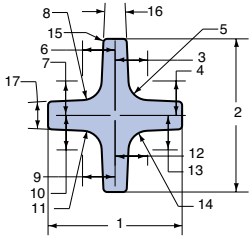

S168

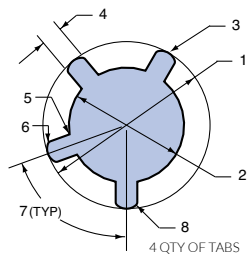

S169

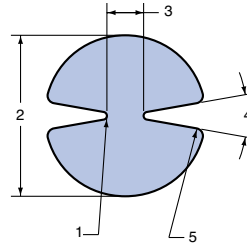

S171

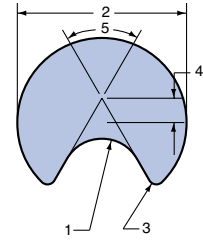

S172

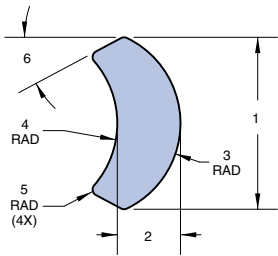

S174

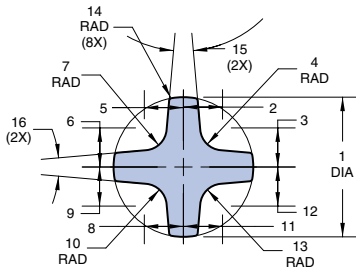

S176

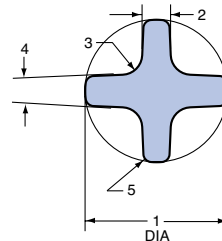

S177

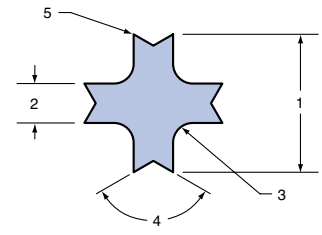

S179

GROUP "C"

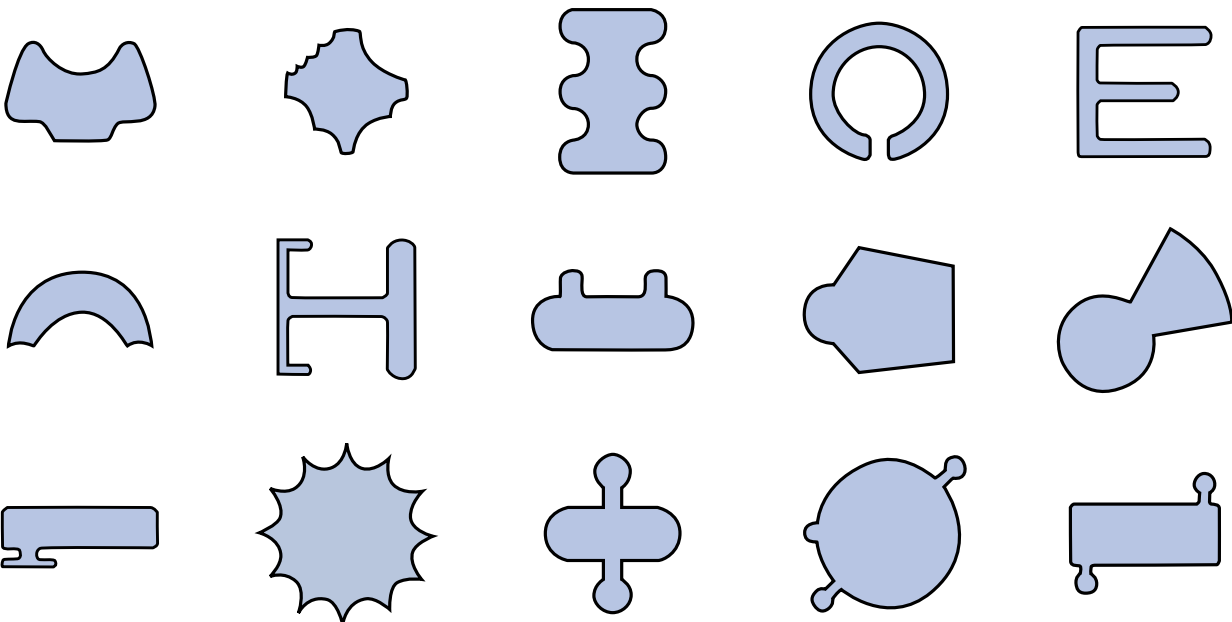

ORDER Minimum order is

CREDIT REQUIREMENTS All orders are subject to approval by our Credit Department. If you are a new account, please furnish us with your tax exempt status, a bank reference, three current supplier references and/or your current D&B rating with your first order. A credit limit will be imposed on new accounts until credit has been established.

PAYMENT TERMS Terms are net 10 days. Catalog prices are subject to change without notice.

FREIGHT Orders are shipped F.O.B. from our manufacturing facility.(International Shipments are Incoterms: Ex Works).

ORDER CANCELLATION In the event an order is cancelled, an additional charge will be assessed to cover the cost of labor and material.

RETURNED MATERIAL A handling/restocking fee will be applied to all standard products returned for credit. A return authorization number and shipping instructions must be obtained in advance before an item can be returned.

CLAIMS All claims or product shortages must be made within 30 days of the invoice date.

WORLD HEADQUARTERS

Wilson Tool International - United States

Tel (Free): 800-328-9646 | Tel: 651-286-6001
Fax (Free): 800-222-0002 | Fax: 651-286-5959
Email: sales@wilsontool.com

NORTH AMERICA

Wilson Tool - Canada

Punching and Stamping Division
Tel: 800-268-5573 | Fax: 800-668-9314
Email: punching@wilsontoolcanada.com

Wilson Tool - Canada

Press Brake Division
Tel: 905-840-2240 | Fax: 905-840-1032
Email: bending@wilsontoolcanada.com

Wilson Tool - Mexico

Tel: 52 (81) 8865-4820 | Fax: 52 (81) 8865-4599
Email: americalatina@wilsontool.com

SOUTH AMERICA

Wilson Tool - Argentina

Tel: +54 114 7996519
Email: ventasargentina@wilsontool.com

Milling Ferramentas - Brazil

Tel/Fax: 55 11 5621-2100
Email: vendas@millling.com.br

CHINA / PACIFIC RIM

Wilson Tool - China

Tel: +86 21 51089638 | Fax: +86 21 64422195
Email: sales@wilsontool.cn

EUROPE / MIDDLE EAST / AFRICA

Wilson Tool - United Kingdom

Tel (Free): 0800-373748 | Tel: +44 1793 831818
Fax (Free): 0800-373758 | Fax: +44 1793 831945 or 46
Email: sales@wilsontool.eu.com

Wilson Tool - Germany

Tel (Free): 00800-9457668665 | Tel: +49 5723 747 0
Fax (Free): 00800-945766329 | Fax: +49 5723 747 10
Email: verkauf@wilsontool.eu.com

Wilson Tool - Denmark

Tel (Free): 80 20 20 24 | Tel: +45 44 53 1699
Fax (Free): 80 20 20 26 | Fax: +45 44 53 0607
Email: sales@wilsontool.dk

Wilson Tool - France

Tel: +33 (0) 164 13 47 80 | Fax: +33 (0) 164 13 47 81
Email: ventes@wilsontool.eu.com

Toolspress - Italy

Tel: +39 0521 850510 / 850677
Fax: +39 0521 850796
Email: info@toolspress.com

Distributor Romania:

S.C. SM TECH S.R.L.

www.sm-tech.ro

www.wilsontool.ro

office @ sm-tech.ro

Tel: 0374-991480

Tel mob: 0745-528494

Fax: 0374-091010